

# State of Nebraska - INVITATION TO BID

## ONE TIME PURCHASE

<b>Date</b>	8/30/22	<b>Page</b>	1 of 1
<b>Solicitation Number</b>	6722 OF		
<b>Opening Date and Time</b>	09/27/22 2:00 PM		
<b>Buyer</b>	BRENDA SENSIBAUGH (AS)		

**DESTINATION OF GOODS**

**CORRECTIONS - TECUMSEH STATE CORREC CTR**  
**2725 N HIGHWAY 50**  
**TECUMSEH NE 68450**

Per Nebraska's Transparency in Government Procurement Act, DAS is required to collect statistical information regarding the number of contracts awarded to Nebraska contractors. This information is for statistical purposes only and will not be considered for contract award purposes.

\_\_\_\_ NEBRASKA CONTRACTOR AFFIDAVIT: Bidder hereby attests that bidder is a Nebraska Contractor. "Nebraska Contractor" shall mean any bidder who has maintained a bona fide place of business and at least one employee within this state for at least the six (6) months immediately preceding the posting date of this ITB.

\_\_\_\_ I hereby certify that I am a Resident disabled veteran or business located in a designated enterprise zone in accordance with Neb. Rev. Stat. §73-107 and wish to have preference, if applicable, considered in the award of this contract.

One Time Purchase to supply and deliver Southern Folger Locks for Tecumseh State Correctional Institution to the State of Nebraska as per the attached specifications.

A response to this Solicitation is subject to, but not limited to, the Standard Terms and Conditions. PLEASE READ CAREFULLY!

This form is part of the specification package and must be signed and returned, along with all documents, by the opening date and time specified.

(MH 8/29/22)

### INVITATION

Line	Description	Quantity	Unit of Measure	Unit Price	Extended Price
1	SOUTHERN FOLGER 1010.01 AM 1-SIDE KEYWAY 1/2" PROJ - CODE	100.0000	EA	\$475.00	\$47,500.00

### BIDDER MUST COMPLETE THE FOLLOWING

DISCOUNT PAYMENT TERMS: \_\_\_\_\_ % \_\_\_\_\_ DAYS

By signing this Invitation to Bid form, the bidder guarantees compliance with the provisions stated in this Invitation to Bid, agrees to the terms and conditions unless otherwise agreed to and certifies that bidder maintains a drug free work place environment. Vendor will furnish the items requested within 56-70 days after receipt of order. Failure to enter Delivery Date may cause quotation to be REJECTED.

**Sign Here**   
 (Authorized Signature Mandatory – Form must be signed manually in ink or by DocuSign)

Enter Contact Information Below

**VENDOR#** \_\_\_\_\_  
**VENDOR:** C.A. OWENS & ASSOCIATES, INC.  
**Address:** 26A SITE C6 ROAD  
 FREEPORT, FLORIDA 32439

**Contact** JACQUELINE OWENS  
**Telephone** (352) 222-9147  
**Email** JACQUELINE@CAOWENSINC.COM

# INVITATION TO BID

## Number 6722 OF

The State of Nebraska (State), Department of Administrative Services (DAS), Materiel Division, State Purchasing Bureau (SPB), is issuing this solicitation for a one-time purchase, ITB Number 6722 OF for the purpose of selecting a qualified Vendor to provide Southern Folger Locks for Tecumseh State Correctional Institution. A more detailed description can be found in Section VI. The resulting contract may not be an exclusive contract as the State reserves the right to contract for the same or similar goods from other sources now or in the future.

### INFORMATION PERTINENT TO THIS SOLICITATION CAN BE FOUND ON THE INTERNET AT:

<http://das.nebraska.gov/materiel/purchasing.html>

**IMPORTANT NOTICE:** Pursuant to Neb. Rev. Stat. § 84-602.02, State contracts in effect as of January 1, 2014, and contracts entered into thereafter, must be posted to a public website. The resulting contract, the solicitation, and the successful Contractor's proposal or response will be posted to a public website managed by DAS, which can be found at:

<https://statecontracts.nebraska.gov>

In addition and in furtherance of the State's public records Statute (Neb. Rev. Stat. § 84-712 et seq.), all bids received regarding this solicitation will be posted to the SPB public website.

These postings will include the entire bid or response. Bidder must request that proprietary information be excluded from the posting. The Bidder must identify the proprietary information, mark the proprietary information according to state law, and submit the proprietary information in a separate container or envelope marked conspicuously using an indelible method with the words "PROPRIETARY INFORMATION". The Bidder must submit a **detailed written document showing** that the release of the proprietary information would give a business advantage to named business competitor(s) and explain how the named business competitor(s) will gain an actual business advantage by disclosure of information. The mere assertion that information is proprietary or that a speculative business advantage might be gained is not sufficient. (See Attorney General Opinion No. 92068, April 27, 1992) **THE BIDDER MAY NOT ASSERT THAT THE ENTIRE BID OR RESPONSE IS PROPRIETARY. COST WILL NOT BE CONSIDERED PROPRIETARY AND IS A PUBLIC RECORD IN THE STATE OF NEBRASKA.** The State will then determine, in its discretion, if the interests served by nondisclosure outweighs any public purpose served by disclosure. (See Neb. Rev. Stat. § 84-712.05(3)) The Bidder will be notified of the agency's decision. Absent a State determination that information is proprietary, the State will consider all information a public record subject to release regardless of any assertion that the information is proprietary.

If the agency determines it is required to release proprietary information, the Vendor will be informed. It will be the Bidder's responsibility to defend the Bidder's asserted interest in non-disclosure.

To facilitate such public postings, with the exception of proprietary information, the State of Nebraska reserves a royalty-free, nonexclusive, and irrevocable right to copy, reproduce, publish, post to a website, or otherwise use any contract, bid, or response to this ITB for any purpose, and to authorize others to use the documents. Any individual or entity awarded a contract, or who submits a bid or response to this solicitation, specifically waives any copyright or other protection the contract, proposal, or response to the solicitation may have; and acknowledges that they have the ability and authority to enter into such waiver. This reservation and waiver are a prerequisite for submitting a bid or response to this ITB, and award of a contract. Failure to agree to the reservation and waiver will result in the bid or response to the ITB being found non-responsive and rejected.

**Any entity awarded a contract or submitting a bid or response to the solicitation agrees not to sue, file a claim, or make a demand of any kind, and will indemnify and hold harmless the State and its employees, volunteers, agents, and its elected and appointed officials from and against any and all claims, liens, demands, damages, liability, actions, causes of action, losses, judgments, costs, and expenses of every nature, including investigation costs and expenses, settlement costs, and attorney fees and expenses, sustained or asserted against the State, arising out of, resulting from, or attributable to the posting of the contract or the bids and responses to the solicitation, awards, and other documents.**

# TABLE OF CONTENTS

INVITATION TO BID.....		i
TABLE OF CONTENTS.....		ii
GLOSSARY OF TERMS.....		iv
ACRONYM LIST.....		viii
<b>I. PROCUREMENT PROCEDURE.....</b>		<b>1</b>
A. GENERAL INFORMATION.....		1
B. PROCURING OFFICE AND COMMUNICATION WITH STATE STAFF AND EVALUATORS.....		1
C. SCHEDULE OF EVENTS.....		2
D. WRITTEN QUESTIONS AND ANSWERS.....		3
E. SECRETARY OF STATE/TAX COMMISSIONER REGISTRATION REQUIREMENTS (Statutory).....		3
F. ETHICS IN PUBLIC CONTRACTING.....		3
G. DEVIATIONS FROM THE INVITATION TO BID.....		3
H. SUBMISSION OF BIDS.....		3
I. BID PREPARATION COSTS.....		4
J. FAILURE TO COMPLY WITH INVITATION TO BID.....		4
K. BID CORRECTIONS.....		4
L. LATE BIDS.....		5
M. BID OPENING.....		5
N. INVITATION TO BID REQUIREMENTS.....		5
O. EVALUATION COMMITTEE.....		5
P. EVALUATION OF BIDS.....		5
Q. BEST AND FINAL OFFER.....		6
R. REFERENCE AND CREDIT CHECKS.....		6
S. AWARD.....		6
T. SPECIFICATIONS.....		6
U. ALTERNATE/EQUIVALENT BIDS.....		7
V. LUMP SUM OR" ALL OR NONE" BIDS.....		7
W. EMAIL SUBMISSIONS.....		7
X. BID TABULATIONS.....		7
Y. REJECTION OF BIDS.....		7
Z. RESIDENT BIDDER.....		7
<b>II. TERMS AND CONDITIONS.....</b>		<b>8</b>
A. GENERAL.....		8
B. NOTIFICATION.....		9
C. NOTICE (POC).....		9
D. GOVERNING LAW (Statutory).....		9
E. CHANGE ORDERS OR SUBSTITUTIONS.....		9
F. VENDOR PERFORMANCE REPORT(S).....		10
G. NOTICE OF POTENTIAL VENDOR BREACH.....		10
H. BREACH.....		10
I. NON-WAIVER OF BREACH.....		11
J. SEVERABILITY.....		11
K. INDEMNIFICATION.....		11
L. ATTORNEY'S FEES.....		12
M. ASSIGNMENT, SALE, OR MERGER.....		12
N. CONTRACTING WITH OTHER POLITICAL SUB-DIVISIONS OF THE STATE OR ANOTHER STATE.....		12
O. FORCE MAJEURE.....		13
P. CONFIDENTIALITY.....		13
<b>III. VENDOR DUTIES.....</b>		<b>14</b>
A. INDEPENDENT VENDOR / OBLIGATIONS.....		14
B. EMPLOYEE WORK ELIGIBILITY STATUS.....		14
C. COMPLIANCE WITH CIVIL RIGHTS LAWS AND EQUAL OPPORTUNITY EMPLOYMENT / NONDISCRIMINATION (Statutory).....		15
D. COOPERATION WITH OTHER VENDORS.....		15
E. DISCOUNTS.....		15
F. PRICES.....		15

G.	COST CLARIFICATION.....	16
H.	PERMITS, REGULATIONS, LAWS .....	16
I.	OWNERSHIP OF INFORMATION AND DATA / DELIVERABLES .....	16
J.	NOTICE OF POTENTIAL VENDOR BREACH .....	16
K.	ANTITRUST.....	17
L.	CONFLICT OF INTEREST .....	17
M.	STATE PROPERTY.....	17
N.	SITE RULES AND REGULATIONS.....	18
O.	ADVERTISING .....	18
P.	DISASTER RECOVERY/BACK UP PLAN.....	18
Q.	DRUG POLICY .....	18
R.	WARRANTY .....	18
<b>IV.</b>	<b>PAYMENT .....</b>	<b>20</b>
A.	PROHIBITION AGAINST ADVANCE PAYMENT (Statutory).....	20
B.	TAXES (Statutory) .....	20
C.	INVOICES.....	20
D.	INSPECTION AND APPROVAL .....	20
E.	PAYMENT (Statutory).....	20
F.	LATE PAYMENT (Statutory).....	20
G.	SUBJECT TO FUNDING / FUNDING OUT CLAUSE FOR LOSS OF APPROPRIATIONS (Statutory).....	20
H.	RIGHT TO AUDIT (First Paragraph is Statutory).....	20
<b>V.</b>	<b>SCOPE OF WORK .....</b>	<b>22</b>
A.	SCOPE .....	22
<b>VI.</b>	<b>TECHNICAL SPECIFICATIONS .....</b>	<b>22</b>
A.	BIDDER INSTRUCTIONS .....	22
B.	NON-COMPLIANCE STATEMENT .....	22
C.	TECHNICAL SPECIFICATIONS: SOUTHERN FOLGER LOCKS .....	23
D.	ACCEPTABLE BRANDS .....	23
E.	DELIVERY ARO .....	24
F.	DELIVERY LOCATIONS / INSTRUCTIONS (VENDOR AGREES THAT THEY CAN MEET THE DELIVERY LOCATIONS/INSTRUCTIONS).....	24
G.	PACKAGING .....	24
H.	ORDERS .....	24
I.	QUALITY .....	25
J.	GRAY MARKET PRODUCTS PROHIBITION .....	25
K.	AUTHORIZED DEALER & WARRANTY .....	25
L.	WARRANTY .....	26
M.	SAMPLES.....	26
N.	PERFORMANCE TESTING .....	27

## GLOSSARY OF TERMS

**Acceptance Test Procedure:** Benchmarks and other performance criteria, developed by the State or other sources of testing standards, for measuring the effectiveness of products or goods and the means used for testing such performance.

**Addendum:** Something to be added or deleted to an existing document; a supplement.

**After Receipt of Order:** After Receipt of Order.

**Agency:** Using agencies shall mean and include all officers of the state, departments, bureaus, boards, commissions, councils, and institutions receiving legislative appropriations.

**Agent/Representative:** A person authorized to act on behalf of another.

**Amend:** To alter or change by adding, subtracting, or substituting.

**Amendment:** A written correction or alteration to a document.

**Appropriation:** Legislative authorization to expend public funds for a specific purpose. Money set apart for a specific use.

**Automated Clearing House:** Electronic network for financial transactions in the United States.

**Award:** All purchases, leases, or contracts which are based on competitive proposals will be awarded according to the provisions in the solicitation.

**Best and Final Offer:** In a competitive bid, the final offer submitted which contains vendor's most favorable terms for price.

**Bid Bond:** An insurance agreement, accompanied by a monetary commitment, by which a third party (the surety) accepts liability and guarantees that the vendor will not withdraw the bid.

**Bidder:** A vendor who submits an offer bid in response to a written solicitation.

**Breach:** Violation of a contractual obligation by failing to perform or repudiation of one's own promise.

**Business:** Any corporation, partnership, individual, sole proprietorship, joint-stock company, joint venture, or any other private legal entity.

**Business Day:** Any weekday, except State-recognized holidays.

**Calendar Day:** Every day shown on the calendar including Saturdays, Sundays, and State/Federal holidays.

**Cancellation:** To call off or revoke a bid, purchase order or contract without expectation of conducting or performing at a later time.

**Catalog/Non-Core:** A printed or electronic list of products a contractor may provide at a discounted rate or discount off list price to the State. Initial contract award(s) is not based on Catalog/Non-Core items.

**Central Processing Unit:** Any computer or computer system that is used by the State to store, process, or retrieve data or perform other functions using Operating Systems and applications software.

**Change Order:** Document that provides amendments to an executed purchase order.

**Collusion:** An agreement or cooperation between two or more persons or entities to accomplish a fraudulent, deceitful, or unlawful purpose.

**Commodities:** Any equipment, material, supply, or goods; anything movable or tangible that is provided or sold.

**Commodities Description:** Detailed descriptions of the items to be purchased; may include information necessary to obtain the desired quality, type, color, size, shape, or special characteristics necessary to perform the work intended to produce the desired results.

**Competition:** The effort or action of two or more commercial interests to obtain the same business from third parties.

**Confidential Information:** Unless otherwise defined below, "Confidential Information" shall also mean proprietary trade secrets, academic and scientific research work which is in progress and unpublished, and other information which if released would give advantage to business competitors and serve no public purpose (see Neb. Rev. Stat. §84-712.05(3)). In accordance with Nebraska Attorney General Opinions 92068 and 97033, proof that information is proprietary requires identification of specific, named competitor(s) who would be advantaged by release of the information and the specific advantage the competitor(s) would receive.

**Contract:** An agreement between two or more parties creating obligations that are enforceable or otherwise recognizable at law; the writing that sets forth such an agreement.

**Contract Administration:** The management of the contract which includes and is not limited to contract signing, contract amendments and any necessary legal actions.

**Contract Management:** The management of day-to-day activities at the agency which includes and is not limited to ensuring deliverables are received, specifications are met, handling meetings, and making payments to the Vendor.

**Contract Period:** The duration of the contract.

**Contractor:** An individual or entity lawfully conducting business in the State, who seeks or agrees to provide goods or services under the terms of a written contract.

**Cooperative Purchasing:** The combining of requirements of two or more political entities to obtain advantages of volume purchases, reduction in administrative expenses or other public benefits.

**Copyright:** A property right in an original work of authorship fixed in any tangible medium of expression, giving the holder the exclusive right to reproduce, adapt and distribute the work.

**Core List:** Items specifically listed on the solicitation upon which a proposal is evaluated for award.

**Critical Program Error:** Any Program Error, whether or not known to the State, which prohibits or significantly impairs use of the Licensed Software as set forth in the documentation and intended in the contract.

**Customer Service:** The process of ensuring customer satisfaction by providing assistance and advice on those products or goods provided by a Vendor.

**Default:** The omission or failure to perform a contractual duty.

**Deviation:** Any proposed change(s) or alteration(s) to either the terms and conditions or deliverables within the scope of the written solicitation or contract

**Evaluation:** The process of examining an offer after opening to determine the vendor's responsibility, responsiveness to requirements, and to ascertain other characteristics of the offer that relate to determination of the successful award.

**Extension:** Continuance of a contract for a specified duration upon the agreement of the parties beyond the original Contract Period. Not to be confused with "Renewal Period".

**Free on-Board Destination:** The delivery charges are included in the quoted price and prepaid by the vendor. Vendor is responsible for all claims associated with damages during delivery of product.

**Free on-Board Point of Origin:** The delivery charges are not included in the quoted price and are the responsibility of the agency. Agency is responsible for all claims associated with damages during delivery of product

**Foreign Corporation:** A foreign corporation that was organized and chartered under the laws of another state, government, or country.

**Installation Date:** The date when the procedures described in "Installation by Vendor ", and "Installation by State", as found in the solicitation, or contract are completed.

**Interested Party:** A person, acting in their personal capacity, or an entity entering into a contract or other agreement creating a legal interest therein.

**Invalid Bid:** A bid that does not meet the requirements of the solicitation or cannot be evaluated against the other bids.

**Invitation to Bid:** A written solicitation utilized for obtaining competitive offers for Services or Goods.

**Late Bid:** An offer received after the Opening Date and Time.

**Licensed Software Documentation:** The user manuals and any other materials in any form or medium customarily provided by the Vendor to the users of the Licensed Software which will provide the State with sufficient information to operate, diagnose, and maintain the Licensed Software properly, safely, and efficiently.

**Mandatory:** Required, compulsory, or obligatory.

**May:** Discretionary, permitted; used to express possibility.

**Module:** A collection of routines and data structures that perform a specific function of software.

**Must:** See “Mandatory”.

**National Institute for Governmental Purchasing:** National Institute of Governmental Purchasing – Source used for assignment of universal commodity codes to goods and services.

**Non-core:** See “Catalog”.

**Open Market Purchase:** Authorization may be given to an agency to purchase items above direct purchase authority due to the unique nature, price, quantity, location of the using agency, or time limitations by the AS Materiel Division, State Purchasing Bureau.

**Opening Date and Time:** Specified date and time for the public opening of received, labeled, and sealed formal bids.

**Operating System:** The control program in a computer that provides the interface to the computer hardware and peripheral devices, and the usage and allocation of memory resources, processor resources, input/output resources, and security resources.

**Outsourcing:** The contracting out of a business process which an organization may have previously performed internally or has a new need for, to an independent organization from which the process is purchased back.

**Payroll & Financial Center:** Electronic procurement system of record.

**Performance Bond:** An insurance agreement, accompanied by a monetary commitment, by which a third party (the surety) accepts liability and guarantees that the Vendor fulfills any and all obligations under the contract

**Platform:** A specific hardware and Operating System combination that is different from other hardware and Operating System combinations to the extent that a different version of the Licensed Software product is required to execute properly in the environment established by such hardware and Operating System combination.

**Point of Contact:** The person designated to receive communications and to communicate.

**Pre-Bid Conference:** A meeting scheduled for the purpose of clarifying a written solicitation and related expectations.

**Product:** Something that is distributed commercially for use or consumption and that is usually (1) tangible personal property, (2) the result of fabrication or processing, and (3) an item that has passed through a chain of commercial distribution before ultimate use or consumption.

**Program Error:** Code in Licensed Software which produces unintended results or actions, or which produces results or actions other than those described in the specifications. A program error includes, without limitation, any Critical Program Error.

**Program Set:** The group of programs and products, including the Licensed Software specified in the solicitation, plus any additional programs and products licensed by the State under the contract for use by the State.

**Project:** The total scheme, program, or method worked out for the accomplishment of an objective, including all documentation, commodities, and goods to be provided under the contract.

**Proposal:** An offer, bid, or quote submitted by a vendor in a response to a written solicitation.

**Proprietary Information:** Proprietary information is defined as trade secrets, academic and scientific research work which is in progress and unpublished, and other information which if released would give advantage to business competitors and service no public purpose (see Neb. Rev. Stat. § 84-712.05(3)). In accordance with Attorney General Opinions 92068 and 97033, proof that information is proprietary requires identification of specific named competitor(s) advantaged by release of the information and the demonstrated advantage the named competitor(s) would gain by the release of information.

**Protest/Grievance:** A complaint about a governmental action or decision related to the solicitation or resultant contract, brought by a vendor who has timely submitted a bid response in connection with the award in question, to AS Materiel Division or another designated agency with the intention of achieving a remedial result.

**Public Bid Opening:** The process of opening correctly submitted offers at the time and place specified in the written solicitation and in the presence of anyone who wished to attend.

**Quote:** See “Bid”.

**Recommended Hardware Configuration:** The data processing hardware (including all terminals, auxiliary storage, communication, and other peripheral devices) to the extent utilized by the State as recommended by the Vendor.

**Release Date:** The date of public release of the written solicitation to seek offers.

**Renewal Period:** Optional contract periods subsequent to the original Contract Period for a specified duration with previously agreed to terms and conditions. Not to be confused with Extension.

**Responsible Vendor:** A Vendor who has the capability in all respects to perform fully and lawfully all requirements with integrity and reliability to assure good faith performance

**Responsive Vendor:** A Vendor who has submitted a bid which conforms to all requirements of the solicitation document.

**Shall:** See "Mandatory".

**Should:** Expected; suggested, but not necessarily mandatory.

**Software License:** Legal instrument with or without printed material that governs the use or redistribution of licensed software.

**Sole Source – Commodity:** When an item is available from only one source due to the unique nature of the requirement, its vendor, or market conditions.

**Specifications:** The detailed statement, especially of the measurements, quality, materials, and functional characteristics, or other items to be provided under a contract.

**Statutory:** These clauses are controlled by state law and are not subject to negotiation.

**Subcontractor:** Individual or entity with whom the contractor enters a contract to perform a portion of the work awarded to the vendor.

**System:** Any collection or aggregation of two (2) or more Modules that is designed to function or is represented by the Vendor as functioning or being capable of functioning, as an entity.

**Termination:** Occurs when the contract expires or either party, pursuant to a power created by agreement or law puts an end to the contract prior to the stated expiration date. All obligations which are still executory on both sides are discharged but any right based on prior breach or performance survives.

**Third-Party:** Any person or entity, including but not limited to fiduciaries, shareholders, owners, officers, managers, employees, legally disinterested persons, and sub-contractors or agents, and their employees. It shall not include any entity or person who is an interested Party to the contract or agreement.

**Trade Secret:** Information, including, but not limited to, a drawing, formula, pattern, compilation, program, device, method, technique, code, or process that (a) derives independent economic value, actual or potential, from not being known to, and not being ascertainable by proper means by, other persons who can obtain economic value from its disclosure or use; and (b) is the subject of efforts that are reasonable under the circumstances to maintain its secrecy (see Neb. Rev. Stat. § 87-502(4)).

**Trademark:** A word, phrase, logo, or other graphic symbol used by a manufacturer or vendor to distinguish its product from those of others, registered with the U.S. Patent and Trademark Office.

**Upgrade:** Any change that improves or alters the basic function of a product of service.

**Vendor Performance Report:** A report completed by the using agency and submitted to State Purchasing Bureau documenting products or services delivered or performed which exceed or fail to meet the terms of the purchase order, contract, and/or solicitation specifications.

**Vendor:** An individual or entity lawfully conducting business in the State and registered with the State to do so, or licensed to do so, who seeks to provide goods or goods under the terms of a written solicitation.

**Will:** See Mandatory/Must/Shall.

**Work Day:** See Business Day.



## ACRONYM LIST

**ARO** – After Receipt of Order

**ACH** – Automated Clearing House

**BAFO** – Best and Final Offer

**COI** – Certificate of Insurance

**CPU** – Central Processing Unit

**DAS** – Department of Administrative Services

**F.O.B.** – Free on Board

**ITB** – Invitation to Bid

**NIGP** – National Institute for Governmental Purchasing

**PA** – Participating Addendum

**RFI** – Request for Information

**RFP** – Request for Proposal

**SPB** – State Purchasing Bureau

**I. PROCUREMENT PROCEDURE**

**A. GENERAL INFORMATION**

The solicitation is designed to solicit proposals from qualified Contractors who will be responsible for providing Southern Folger Locks for Tecumseh State Correctional Institution at a competitive and reasonable cost. Terms and Conditions, Project Description and Scope of Work, bid instructions, and Cost Bid Requirements may be found in Sections II through VI.

Bids shall conform to all instructions, conditions, and requirements included in the solicitation. Prospective Vendors are expected to carefully examine all documents, schedules, and requirements in this ITB, and respond to each requirement in the format prescribed. Bids may be found non-responsive if they do not conform to the ITB.

**B. PROCURING OFFICE AND COMMUNICATION WITH STATE STAFF AND EVALUATORS**

Procurement responsibilities related to this ITB reside with SPB. The point of contact (POC) for the procurement is as follows:

Name: Brenda Sensibaugh, Procurement Contracts Officer  
Agency: State Purchasing Bureau  
Address: 1526 K Street, Suite 130  
Lincoln, NE 68508

Telephone: 402-471-6500

E-Mail: [as.materielpurchasing@nebraska.gov](mailto:as.materielpurchasing@nebraska.gov)

From the date the ITB is issued until the Intent to Award is issued, communication from the Vendor is limited to the POC listed above. After the Intent to Award is issued, the Vendor may communicate with individuals the State has designated as responsible for negotiating the contract on behalf of the State. No member of the State Government, employee of the State, or member of the Evaluation Committee is empowered to make binding statements regarding this solicitation. The POC will issue any answers, clarifications, or amendments regarding this solicitation in writing. Only the SPB or awarding agency can award a contract. Vendors shall not have any communication with or attempt to communicate or influence any evaluator involved in this solicitation.

The following exceptions to these restrictions are permitted:

1. Contact made pursuant to pre-existing contracts or obligations;
2. Contact required by the schedule of events, or an event scheduled later by POC; and
3. Contact required for negotiation and execution of the final contract.

*The State reserves the right to reject a vendor's bid, withdraw an Intent to Award, or terminate a contract if the State determines there has been a violation of these procurement procedures.*

**C. SCHEDULE OF EVENTS**

The State expects to adhere to the procurement schedule shown below, but all dates are approximate and subject to change.

ACTIVITY		DATE/TIME
1.	Release ITB	9-1-22
	Last day to submit written questions	
2.	Upload Electronic Questions via Sharefile Link: <a href="https://nebraska.sharefile.com/r-r4c21937b591745d08449dbe9bdb82429">https://nebraska.sharefile.com/r-r4c21937b591745d08449dbe9bdb82429</a>	9-14-22
3.	State responds to written questions through a solicitation "Addendum" and/or "Amendment" to be posted to the Internet at: <a href="https://das.nebraska.gov/materiel/purchasing.html">https://das.nebraska.gov/materiel/purchasing.html</a>	9-16-22
	Bid Opening	
	Upload Electronic Bid via Sharefile link: <a href="https://nebraska.sharefile.com/r-r6af06feb872c4c46869f31a02241a999">https://nebraska.sharefile.com/r-r6af06feb872c4c46869f31a02241a999</a>	
	<b>IT IS THE BIDDER'S RESPONSIBILITY TO UPLOAD ELECTRONIC FILES WITH AN ADEQUATE AMOUNT OF TIME IN CASE OF USER ISSUE, SOFTWARE ISSUE OR BROWSER ISSUE.</b>	
4.	Topic: Bid Opening for 6722 OF Southern Folger Locks for Tecumseh State Correctional Institution Time: Sep 27, 2022, 02:00 PM Central Time (US and Canada)	9-27-22 2:00 PM Central Time
	Join Zoom Meeting <a href="https://us02web.zoom.us/j/2629176739?pwd=NkhobXNpOU94UmFmTG1wYmJqTXhpUT09">https://us02web.zoom.us/j/2629176739?pwd=NkhobXNpOU94UmFmTG1wYmJqTXhpUT09</a>	
	Meeting ID: 262 917 6739 Passcode: 5VwBuR	
	<b>It is the bidder's responsibility to make sure they are able to join the zoom meeting prior to the meeting.</b>	
5.	Post "Notification of Intent to Award" to Internet at: <a href="http://das.nebraska.gov/materiel/purchasing.html">http://das.nebraska.gov/materiel/purchasing.html</a>	TBD

**D. WRITTEN QUESTIONS AND ANSWERS**

Questions regarding the meaning or interpretation of any ITB provision must be submitted in writing to SPB and clearly marked "ITB Number 6722 OF; Southern Folger Locks for Tecumseh State Correctional Institution Questions". POC is not obligated to respond to questions that are received late per the Schedule of Events.

Vendors should present, as questions, any assumptions upon which the Vendor's bid is or might be developed. Bids will be evaluated without consideration of any known or unknown assumptions of a Vendor. The contract will not incorporate any known or unknown assumptions of a Vendor.

Questions must be uploaded using the following ShareFile link:  
<https://nebraska.sharefile.com/r-r4c21937b591745d08449dbe9bdb82429>

-.

ITB Section Reference	ITB Page Number	Question

Written answers will be posted at <http://das.nebraska.gov/materiel/purchasing.html> per the Schedule of Events.

**E. SECRETARY OF STATE/TAX COMMISSIONER REGISTRATION REQUIREMENTS (Statutory)**

All Vendors must be authorized to transact business in the State and comply with all Nebraska Secretary of State Registration requirements. The Vendor who is the recipient of an Intent to Award will be required to certify that it has complied and produce a true and correct copy of its current (within ninety (90) calendar days of the intent to award) Certificate or Letter of Good Standing, or in the case of a sole proprietorship, provide written documentation of sole proprietorship and the United States Citizenship Attestation Form, available on the DAS website at: <http://das.nebraska.gov/materiel/purchasing.html>. This must be accomplished prior to execution of the contract.

**F. ETHICS IN PUBLIC CONTRACTING**

The State reserves the right to reject bids, withdraw an intent to award or award, or terminate a contract if a Vendor commits or has committed ethical violations, which include, but are not limited to:

1. Offering or giving, directly or indirectly, a bribe, fee, commission, compensation, gift, gratuity, or anything of value to any person or entity in an attempt to influence the bidding process;
2. Utilize the services of lobbyists, attorneys, political activists, or consultants to influence or subvert the bidding process;
3. Being considered for, presently being, or becoming debarred, suspended, ineligible, or excluded from contracting with any state or federal entity;
4. Submitting a bid on behalf of another party or entity;
5. Collude with any person or entity to influence the bidding process, submit sham bids, preclude bidding, fix pricing or costs, create an unfair advantage, subvert the bid, or prejudice the State.

The Vendor shall include this clause in any subcontract entered into for the exclusive purpose of performing this contract.

Vendor shall have an affirmative duty to report any violations of this clause by the Vendor throughout the bidding process, and throughout the term of this contract for the successful Vendor and their subcontractors.

**G. DEVIATIONS FROM THE INVITATION TO BID**

The requirements contained in the solicitation (Sections II through VI) become a part of the terms and conditions of the contract resulting from this solicitation. Any deviations from the solicitation in Sections II through VI must be clearly defined by the Vendor in its bid and, if accepted by the State, will become part of the contract. Any specifically defined deviations must not be in conflict with the basic nature of the solicitation, solicitation requirements, or applicable state or federal laws or statutes. "Deviation", for the purposes of this solicitation, means any proposed changes or alterations to either the contractual language or deliverables within the scope of this solicitation. The State discourages deviations and reserves the right to reject proposed deviations.

**H. SUBMISSION OF BIDS**

**\*\*\*ALL BIDS MUST BE SUBMITTED IN A SEALED ENVELOPE OR CONTAINER! \*\*\***

**The State is accepting electronically submitted responses for this ITB.**

**“NO LATE BIDS WILL BE ACCEPTED”**

The Invitation to Bid form must be manually signed in an indelible manner and returned by the bid opening date and time along with the Bidder's Invitation to Bid and any other requirements as stated in the Invitation to Bid document in order for the Bidder's Invitation to Bid response to be evaluated.

Emphasis should be concentrated on conformance to the ITB instructions, responsiveness to requirements, completeness, and clarity of content. If the Bidder's bid is presented in such a fashion that makes evaluation difficult or overly time consuming the State reserves the right to reject the bid as non-responsive.

By signing the Invitation to Bid, the Bidder guarantees compliance with the provisions stated in this ITB.

**1. SUBMITTING ELECTRONIC RESPONSES:**

**Bidders are to upload response via the following ShareFile link:**

<https://nebraska.sharefile.com/r-r6af06feb872c4c46869f31a02241a999>

**IT IS THE BIDDER'S RESPONSIBILITY TO UPLOAD ELECTRONIC FILES WITH AN ADEQUATE AMOUNT OF TIME IN CASE OF USER ISSUE, SOFTWARE ISSUE OR BROWSER ISSUE.**

Note to Bidders: Not all browsers are compatible with ShareFile. Currently Chrome, Internet Explorer and Firefox are compatible.

**2. INSTRUCTIONS TO UPLOAD FILES VIA SHAREFILE:**

- a. Click the link, enter email address, First Name, Last Name and Company, and click "Continue"
- b. Drag files into the "Drag Files Here" area OR browse files to select them manually. Click "Upload" when ready.
- c. A success message will be displayed once the upload is complete. The bidder should receive a confirmation email confirming the successful upload directly from ShareFile.

**3. ELECTRONIC BID FILE NAMES**

The bidder should clearly identify the uploaded ITB bid files. To assist in identification the bidder should use the following naming convention:

- a. ITB 6722 OF, Company Name
- b. If multiple files are submitted for one ITB bid, add number of files to file names: ITB 6722 OF Company Name, 1 of 2.
- c. If multiple ITB bids are submitted for the same ITB, add the ITB number to the file names: ITB 6722 OF Company Name Bid 1 File 1 of 2.

**I. BID PREPARATION COSTS**

The State shall not incur any liability for any costs incurred by Vendors in replying to this solicitation, including any activity related to bidding on this solicitation.

**J. FAILURE TO COMPLY WITH INVITATION TO BID**

Violation of the terms and conditions contained in this solicitation or any resultant contract, at any time before or after the award, shall be grounds for action by the State which may include, but is not limited to, the following:

1. Rejection of a Vendor's Bid;
2. Withdrawal of the Intent to Award;
3. Withdrawal of the Award;
4. Negative Vendor Performance Report(s)
5. Termination of the resulting contract;
6. Legal action; or,
7. Suspension of the Vendor from further bidding with the State for the period of time relative to the seriousness of the violation, such period to be within the sole discretion of the State.

**K. BID CORRECTIONS**

A vendor may correct a mistake in a proposal prior to the time of opening by giving written notice to the State of intent to withdraw the bid for modification or to withdraw the bid completely. Changing a bid after opening may be permitted if the change is made to correct a minor error that does not affect price, quantity, quality, delivery, or contractual conditions. In case of a mathematical error in extension of price, unit price shall govern.

**L. LATE BIDS**

Bids received after the time and date of the bid opening will be considered late bids. Late bids will be returned unopened, if requested by the Vendor and at Vendor's expense. The State is not responsible for bids that are late or lost regardless of cause or fault.

**M. BID OPENING**

Anyone may attend the opening. It is considered a public opening. The Buyer will read the names of the respondents. Depending upon the complexity of the bid for goods, the buyer may read the bids aloud or allow bids to be available for viewing by the public during the bid opening. Once the bid opening has concluded, the bids will not be available for viewing until the Intent to Award has been posted. An initial bid tabulation will be posted to the website as soon as feasible. Information identified as proprietary by the submitting vendor, in accordance with the solicitation and state statute, will not be posted. If the state determines submitted information should not be withheld, in accordance with the [Public Records Act](#), or if ordered to release any withheld information, said information may then be released. The submitting vendor will be notified of the release and it shall be the obligation of the submitting vendor to take further action if it believes the information should not be released.

**N. INVITATION TO BID REQUIREMENTS**

The bids will first be examined to determine if all requirements listed below have been addressed and whether further evaluation is warranted. Bids not meeting the requirements may be rejected as non-responsive. The requirements are:

1. Original Commodity ITB form signed using an indelible method (electronic signatures are acceptable);
2. Clarity and responsiveness of the proposal;
3. Completed Sections II through VI;
4. Completed ITB Form or State's Cost Sheet.

**O. EVALUATION COMMITTEE**

Bids are evaluated by members of an Evaluation Committee(s). The Evaluation Committee(s) will consist of individuals selected at the discretion of the State. Names of the members of the Evaluation Committee(s) will not be published prior to the intent to award.

Any contact, attempted contact, or attempt to influence an evaluator that is involved with this solicitation may result in the rejection of this proposal and further administrative actions.

**P. EVALUATION OF BIDS**

All bids that are responsive to the solicitation will be evaluated based on the following:

1. Cost Bid

**Neb. Rev. Stat. §81-161 allows the quality of performance of previous contracts to be considered when evaluating responses to competitively bid solicitations in determining the lowest responsible bidder.** Information obtained from any Vendor Performance Report (See Terms & Conditions, Section H) may be used in evaluating responses to solicitations for goods and services to determine the best value for the State.

**Neb. Rev. Stat. §73-107 allows for a preference for a resident disabled veteran or business located in a designated enterprise zone.** When a state contract is to be awarded to the lowest responsible contractor, a resident disabled veteran or a business located in a designated enterprise zone under the Enterprise Zone Act shall be allowed a preference over any other resident or nonresident contractor, if all other factors are equal.

**Resident disabled veterans means any person (a) who resides in the State of Nebraska, who served in the United States Armed Forces, including any reserve component or the National Guard, who was discharged or otherwise separated with a characterization of honorable or general (under honorable conditions), and who possesses a disability rating letter issued by the United States Department of Veterans Affairs establishing a service-connected disability or a disability determination from the United States Department of Defense and (b)(i) who owns and controls a business or, in the case of a publicly owned business, more than fifty percent of the stock is owned by one or more persons described in subdivision (a) of this subsection and (ii) the management and daily business operations of the business are controlled by one or more persons described in subdivision(a) of this subsection. Any contract entered into without compliance with this section shall be null and void.**

Therefore, if a resident disabled veteran or business located in a designated enterprise zone submits a proposal in accordance with Neb. Rev. Stat. §73-107 and has so indicated on the ITB cover page under "Vendor must complete

the following” requesting priority/preference to be considered in the award of this contract, the following will need to be submitted by the vendor within ten (10) business days of request:

1. Documentation from the United States Armed Forces confirming service;
2. Documentation of discharge or otherwise separated characterization of honorable or general (under honorable conditions);
3. Disability rating letter issued by the United States Department of Veterans Affairs establishing a service-connected disability or a disability determination from the United States Department of Defense; and
4. Documentation which shows ownership and control of a business or, in the case of a publicly owned business, more than fifty percent of the stock is owned by one or more persons described in subdivision (a) of this subsection; and the management and daily business operations of the business are controlled by one or more persons described in subdivision (a) of this subsection.

Failure to submit the requested documentation within ten (10) business days of notice will disqualify the vendor from consideration of the preference.

**Q. BEST AND FINAL OFFER**

If best and final offers (BAFO) are requested by the State and submitted by the vendor, they will be evaluated (using the stated BAFO criteria) and ranked by the Evaluation Committee. The State reserves the right to conduct more than one BAFO. The award will then be granted to the lowest responsible vendor. However, a vendor should provide its best offer in its original bid. Vendors should not expect that the State will request a BAFO.

**R. REFERENCE AND CREDIT CHECKS**

The State reserves the right to conduct and consider reference and credit checks. The State reserves the right to use third parties to conduct reference and credit checks. By submitting a bid in response to this solicitation, the vendor grants to the State the right to contact or arrange a visit in person with any or all of the vendor’s clients. Reference and credit checks may be grounds to reject a bid, withdraw an intent to award, or rescind the award of a contract.

**S. AWARD**

The State reserves the right to evaluate bids and award contracts in a manner utilizing criteria selected at the State's discretion and in the State’s best interest. After evaluation of the bids, or at any point in the solicitation process, the State of Nebraska may take one or more of the following actions:

1. Amend the solicitation;
2. Extend the time of or establish a new bid opening time;
3. Waive deviations or errors in the State’s solicitation process and in vendor bids that are not material, do not compromise the solicitation process or a vendor’s bid, and do not improve a contractor’s competitive position;
4. Accept or reject a portion of or all of a bid;
5. Accept or reject all bids;
6. Withdraw the solicitation;
7. Elect to rebid the solicitation;
8. Award single lines or multiple lines to one or more contractors; or,
9. Award one or more all-inclusive contracts.

The solicitation does not commit the State to award a contract. Once intent to award decision has been determined, it will be posted to the Internet at:

<http://das.nebraska.gov/materiel/purchasing.html>

Any protests must be filed by a vendor within ten (10) business days after the intent to award decision is posted to the Internet. Grievance and protest procedure is available on the Internet at:

<http://das.nebraska.gov/materiel/purchasing.html>

**T. SPECIFICATIONS**

Any manufacturer’s names, trade names, brand names, information and/or catalog numbers listed in a specification are for reference and not intended to limit competition but will be used as the standard by which equivalent material offered will be judged. The Materiel Administrator will be the sole judge of equivalency. The Vendor may offer any brands which meets or exceeds the specification. When a specific product is required, the solicitation will so state. Any item proposal is to be the latest current model under standard production at the time of order. No used or refurbished equipment will be accepted, unless otherwise stated.

SAMPLES When requested, samples should be furnished at the Vendor's expense prior to the opening of the bid, unless another time is specified. Each sample should be labeled clearly, and identify the Vendor's name, the ITB number, item number, and the brand and model number, if applicable. Samples submitted must be the commodities or equipment which would be delivered if awarded the bid. The State reserves the right to request samples even though this may not have been set forth in the solicitation. Samples may be destroyed in testing. If a sample is not destroyed in testing and a Vendor wishes to have the sample returned, it will be returned at the Vendor's expense upon request. The sample will not be returned until thirty (30) calendar days after any proposal protest or, the execution of a contract. The Vendor shall have ten (10) calendar days to arrange for the return of the sample to the Vendor following any of the above dates. If no request from the Vendor is received within the above dates, the State reserves the right to use, donate, or surplus the samples in accordance with the State's policies.

**U. ALTERNATE/EQUIVALENT BIDS**

Vendor may offer bids which are at variance from the express specifications of the solicitation. The State reserves the right to consider and accept such bids if, in the judgment of the Materiel Administrator, the bid will result in goods and/or services equivalent to or better than those which would be supplied in the original bid specifications. Vendor must indicate on the solicitation the manufacturer's name, number and shall submit with their bid, sketches, descriptive literature and/or complete specifications. Reference to literature submitted with a previous bid will not satisfy this provision. Bids which do not comply with these requirements are subject to rejection. In the absence of any stated deviation or exception, the proposal will be accepted as in strict compliance with all terms, conditions and specification, and the Vendor shall be held liable, therefore.

**V. LUMP SUM OR" ALL OR NONE" BIDS**

The State reserves the right to purchase item-by-item, by groups or as a total when the State may benefit by so doing. Vendors may submit a bid on an "all or none" or "lump sum" basis but should also submit a bid on an item-by-item basis. The term "all or none" means a conditional bid which requires the purchase of all items on which bids are offered and Vendor declines to accept award on individual items; a "lump sum" bid is one in which the Vendor offers a lower price than the sum of the individual bids if all items are purchased but agrees to deliver individual items at the prices quoted.

**W. EMAIL SUBMISSIONS**

SPB will not accept bids by email, voice, or telephone bids **except** for one-time purchases under \$50,000.00.

**X. BID TABULATIONS**

Bid tabulations are available on the website at: <https://das.nebraska.gov/materiel/bidopps.html#CommodityContracts>.

**Y. REJECTION OF BIDS**

The State reserves the right to reject any or all bids, wholly or in part, in the best interest of the State.

**Z. RESIDENT BIDDER**

Pursuant to Neb. Rev. Stat. §§ 73-101.01 through 73-101.02, a Resident Bidder shall be allowed a preference against a Non-resident Bidder from a state which gives or requires a preference to Bidders from that state. The preference shall be equal to the preference given or required by the state of the Nonresident Bidders. Where the lowest responsible bid from a resident Bidder is equal in all respects to one from a nonresident Bidder from a state which has no preference law, the resident Bidder shall be awarded the contract. The provision of this preference shall not apply to any contract for any project upon which federal funds would be withheld because of the provisions of this preference.



**II. TERMS AND CONDITIONS**

**Bidders should complete Section II through VI as part of their proposal.** Bidder is expected to read the Terms and Conditions and must initial either accept, reject, or reject and provide alternative language for each clause. The Bidder should also provide an explanation of why the Bidder rejected the clause or rejected the clause and provided alternate language using "Track Changes". Upon request an electronic copy of the bid with "Track Changes" must be submitted in an editable Word format. By signing the solicitation, Bidder is agreeing to be legally bound by all the accepted terms and conditions, and any proposed alternative terms and conditions submitted with the bid. The State reserves the right to negotiate rejected or proposed alternative language. If the State and Bidder fail to agree on the final Terms and Conditions, the State reserves the right to reject the bid. The State is soliciting bids in response to the solicitation. The State reserves the right to reject proposals that attempt to substitute the Bidder's commercial contracts and/or documents for this solicitation.

The Bidder should submit with their proposal any license, user agreement, service level agreement, or similar documents that the Bidder wants incorporated in the Contract. Upon notice of Intent to Award, the Bidder must submit a copy of these documents in an editable Word format. The State will not consider incorporation of any document not submitted with the Bidder's bid. These documents shall be subject to negotiation and will be incorporated as addendums if agreed to by the Parties.

If a conflict or ambiguity arises after the addendums have been negotiated and agreed to, the addendums shall be interpreted as follows:

1. If only one (1) Party's document has a particular clause then that clause shall control;
2. If both Party's documents have a similar clause, but the clauses do not conflict, the clauses shall be read together;
3. If both Party's documents have a similar clause, but the clauses conflict, the State's clause shall control.

**A. GENERAL**

Accept (Initial)	Reject (Initial)	Reject & Provide Alternative within ITB Response (Initial)	NOTES/COMMENTS:
A			

The contract resulting from this ITB shall incorporate the following documents:

1. Invitation to Bid and Addenda;
2. Amendments to the solicitation;
3. Questions and Answers;
4. Contractor's bid response;
5. The executed Contract and any Addenda, if applicable, and properly submitted documents; and,
6. Amendments to the Contract

The above listed documents constitute the entirety of the contract.

Unless otherwise specifically stated in a future contract amendment, in case of any conflict between the incorporated documents, the documents shall govern in the following order of preference with number one (1) receiving preference over all other documents and with each lower numbered document having preference over any higher numbered document: 1) Amendment to the executed Contract with the most recent dated amendment having the highest priority, 2) executed Contract and any attached Addenda, 3) Amendments to solicitation and any Questions and Answers, 4) the original solicitation document and any Addenda, and 5) the Bidder's submitted Bid.

Any ambiguity or conflict in the contract discovered after its execution, not otherwise addressed herein, shall be resolved in accordance with the rules of contract interpretation as established in the State.

**B. NOTIFICATION**

Accept (Initial)	Reject (Initial)	Reject & Provide Alternative within ITB Response (Initial)	NOTES/COMMENTS:
A			

Vendor and State shall identify the contract manager who shall serve as the point of contact for the executed contract.

Either party may change its address for notification purposes by giving notice of the change, and setting forth the new address and an effective date.

**C. NOTICE (POC)**

The State reserves the right to appoint a Buyer's Representative to manage [or assist the Buyer in managing] the contract on behalf of the State. The Buyer's Representative will be appointed in writing, and the appointment document will specify the extent of the Buyer's Representative authority and responsibilities. If a Buyer's Representative is appointed, the Vendor will be provided a copy of the appointment document and is expected to cooperate accordingly with the Buyer's Representative. The Buyer's Representative has no authority to bind the State to a contract, amendment, addendum, or other change or addition to the contract.

**D. GOVERNING LAW (Statutory)**

Notwithstanding any other provision of this contract, or any amendment or addendum(s) entered into contemporaneously or at a later time, the parties understand and agree that, (1) the State of Nebraska is a sovereign state and its authority to contract is therefore subject to limitation by the State's Constitution, statutes, common law, and regulation; (2) this contract will be interpreted and enforced under the laws of the State of Nebraska; (3) any action to enforce the provisions of this contract must be brought in the State of Nebraska per state law; (4) the person signing this contract on behalf of the State of Nebraska does not have the authority to waive the State's sovereign immunity, statutes, common law, or regulations; (5) the indemnity, limitation of liability, remedy, and other similar provisions of the final contract, if any, are entered into subject to the State's Constitution, statutes, common law, regulations, and sovereign immunity; and, (6) all terms and conditions of the final contract, including but not limited to the clauses concerning third-party use, licenses, warranties, limitations of liability, governing law and venue, usage verification, indemnity, liability, remedy or other similar provisions of the final contract are entered into specifically subject to the State's Constitution, statutes, common law, regulations, and sovereign immunity.

The Parties must comply with all applicable local, state, and federal laws, ordinances, rules, orders, and regulations.

**E. CHANGE ORDERS OR SUBSTITUTIONS**

Accept (Initial)	Reject (Initial)	Reject & Provide Alternative within ITB Response (Initial)	NOTES/COMMENTS:
A			

The State and the Vendor, upon the written agreement, may make changes to the contract within the general scope of the solicitation. Corrections of any goods or service required pursuant to the contract shall not be deemed a change. The Vendor may not claim forfeiture of the contract by reasons of such changes.

The Vendor shall prepare a written description of the work required due to the change and an itemized cost sheet for the change. Changes in work and the amount of compensation to be paid to the Vendor shall be determined in accordance with applicable unit prices if any, a pro-rated value, or through negotiations. The State shall not incur a price increase for changes that should have been included in the Vendor's bid, were foreseeable, or result from difficulties with or failure of the Vendor's bid or performance.

No change shall be implemented by the Vendor until approved by the State, and the Contract is amended to reflect the change and associated costs, if any. If there is a dispute regarding the cost, but both parties agree that immediate

implementation is necessary, the change may be implemented, and cost negotiations may continue with both Parties retaining all remedies under the contract and law.

**\*\*\*Vendor will not substitute any item that has been awarded without prior written approval of SPB\*\*\***

**F. VENDOR PERFORMANCE REPORT(S)**

Accept (Initial)	Reject (Initial)	Reject & Provide Alternative within ITB Response (Initial)	NOTES/COMMENTS:
			

The State may document any instance(s) of products or services delivered or performed which exceed or fail to meet the terms of the purchase order, contract, and/or solicitation specifications. The State Purchasing Bureau may contact the Vendor regarding any such report. Vendor performance report(s) will become a part of the permanent record of the Vendor.

**G. NOTICE OF POTENTIAL VENDOR BREACH**

Accept (Initial)	Reject (Initial)	Reject & Provide Alternative within ITB Response (Initial)	NOTES/COMMENTS:
			

If Vendor breaches the contract or anticipates breaching the contract, the Vendor shall immediately give written notice to the State. The notice shall explain the breach or potential breach, a proposed cure, and may include a request for a waiver of the breach if so desired. The State may, in its discretion, temporarily or permanently waive the breach. By granting a waiver, the State does not forfeit any rights or remedies to which the State is entitled by law or equity, or pursuant to the provisions of the contract. Failure to give immediate notice, however, may be grounds for denial of any request for a waiver of a breach.

**H. BREACH**

Accept (Initial)	Reject (Initial)	Reject & Provide Alternative within ITB Response (Initial)	NOTES/COMMENTS:
			

Either Party may terminate the contract, in whole or in part, if the other Party breaches its duty to perform its obligations under the contract in a timely and proper manner. Termination requires written notice of default and a thirty (30) calendar day (or longer at the non-breaching Party's discretion considering the gravity and nature of the default) cure period. Said notice shall be delivered by Certified Mail, Return Receipt Requested, or in person with proof of delivery. Allowing time to cure a failure or breach of contract does not waive the right to immediately terminate the contract for the same or different contract breach which may occur at a different time.

In case of breach by the Vendor, the State may, without unreasonable delay, make a good faith effort to make a reasonable purchase or contract to purchased goods in substitution of those due from the vendor. The State may recover from the Vendor as damages the difference between the costs of covering the breach. Notwithstanding any clause to the contrary, the State may also recover the contract price together with any incidental or consequential damages defined in UCC Section 2-715, but less expenses saved in consequence of Vendor's breach. OR In case of default of the Vendor, the State may contract the service from other sources and hold the Vendor responsible for any excess cost occasioned thereby.

The State's failure to make payment shall not be a breach, and the Vendor shall retain all available statutory remedies. (See Indemnity - Self-Insurance and Payment)

**I. NON-WAIVER OF BREACH**

Accept (Initial)	Reject (Initial)	Reject & Provide Alternative within ITB Response (Initial)	NOTES/COMMENTS:
			

The acceptance of late performance with or without objection or reservation by a Party shall not waive any rights of the Party nor constitute a waiver of the requirement of timely performance of any obligations remaining to be performed.

**J. SEVERABILITY**

Accept (Initial)	Reject (Initial)	Reject & Provide Alternative within ITB Response (Initial)	NOTES/COMMENTS:
			

If any term or condition of the contract is declared by a court of competent jurisdiction to be illegal or in conflict with any law, the validity of the remaining terms and conditions shall not be affected, and the rights and obligations of the parties shall be construed and enforced as if the contract did not contain the provision held to be invalid or illegal.

**K. INDEMNIFICATION**

Accept (Initial)	Reject (Initial)	Reject & Provide Alternative within ITB Response (Initial)	NOTES/COMMENTS:
			

**1. GENERAL**

The Vendor agrees to defend, indemnify, and hold harmless the State and its employees, volunteers, agents, and its elected and appointed officials ("the indemnified parties") from and against any and all claims, liens, demands, damages, liability, actions, causes of action, losses, judgments, costs, and expenses of every nature, including investigation costs and expenses, settlement costs, and attorney fees and expenses ("the claims"), sustained or asserted against the State for personal injury, death, or property loss or damage, arising out of, resulting from, or attributable to the willful misconduct, negligence, error, or omission of the Vendor, its employees, Subcontractors, consultants, representatives, and agents, resulting from this contract, except to the extent such Vendor liability is attenuated by any action of the State which directly and proximately contributed to the claims.

**2. INTELLECTUAL PROPERTY**

The Vendor agrees it will, at its sole cost and expense, defend, indemnify, and hold harmless the indemnified parties from and against any and all claims, to the extent such claims arise out of, result from, or are attributable to, the actual or alleged infringement or misappropriation of any patent, copyright, trade secret, trademark, or confidential information of any third party by the Contractor or its employees, Subcontractors, consultants, representatives, and agents; provided, however, the State gives the Vendor prompt notice in writing of the claim. The Vendor may not settle any infringement claim that will affect the State's use of the Licensed Software without the State's prior written consent, which consent may be withheld for any reason.

If a judgment or settlement is obtained or reasonably anticipated against the State's use of any intellectual property for which the Vendor has indemnified the State, the Vendor shall, at the Vendor's sole cost and expense, promptly modify the item or items which were determined to be infringing, acquire a license or licenses on the State's behalf to provide the necessary rights to the State to eliminate the infringement, or provide the State with a non-infringing substitute that provides the State the same functionality. At the State's election, the actual or anticipated judgment may be treated as a breach of warranty by the Vendor, and the State may receive the remedies provided under this solicitation.

**3. SELF-INSURANCE (Statutory)**

The State is self-insured for any loss and purchases excess insurance coverage pursuant to Neb. Rev. Stat. § 81-8,239.01 (Reissue 2008). If there is a presumed loss under the provisions of this contract, Vendor may file a claim with the Office of Risk Management pursuant to Neb. Rev. Stat. §§ 81-8,829 through 81-8,306 for review by the State Claims Board. The State retains all rights and immunities under the State Miscellaneous (Section 81-8,294), Tort (Section 81-8,209), and Contract Claim Acts (Section 81-8,302), as outlined in Neb. Rev. Stat. § 81-8,209 et seq. and under any other provisions of law and accepts liability under this contract to the extent provided by law.

**L. ATTORNEY'S FEES**

Accept (Initial)	Reject (Initial)	Reject & Provide Alternative within ITB Response (Initial)	NOTES/COMMENTS:
			

In the event of any litigation, appeal, or other legal action to enforce any provision of the contract, the Parties agree to pay all expenses of such action, as permitted by law and if ordered by the court, including attorney's fees and costs, if the other party prevails.

**M. ASSIGNMENT, SALE, OR MERGER**

Accept (Initial)	Reject (Initial)	Reject & Provide Alternative within ITB Response (Initial)	NOTES/COMMENTS:
			

Either party may assign the contract upon mutual written agreement of the other party. Such agreement shall not be unreasonably withheld.

The Vendor retains the right to enter into a sale, merger, acquisition, internal reorganization, or similar transaction involving Vendor's business. Vendor agrees to cooperate with the State in executing amendments to the contract to allow for the transaction. If a third party or entity is involved in the transaction, the Vendor will remain responsible for performance of the contract until such time as the person or entity involved in the transaction agrees in writing to be contractually bound by this contract and perform all obligations of the contract.

**N. CONTRACTING WITH OTHER POLITICAL SUB-DIVISIONS OF THE STATE OR ANOTHER STATE**

Accept (Initial)	Reject (Initial)	Reject & Provide Alternative within ITB Response (Initial)	NOTES/COMMENTS:
			

The Vendor may, but shall not be required to, allow agencies, as defined in Neb. Rev. Stat. § 81-145, to use this contract. The terms and conditions, including price, of the contract may not be amended. The State shall not be contractually obligated or liable for any contract entered into pursuant to this clause.

The Vendor may, but shall not be required to, allow other states, agencies or divisions of other states, or political subdivisions of other states to use this contract. The terms and conditions, including price, of this contract shall apply to any such contract, but may be amended upon mutual consent of the Parties. The State of Nebraska shall not be contractually or otherwise obligated or liable under any contract entered into pursuant to this clause. The State shall be notified if a contract is executed based upon this contract.

**O. FORCE MAJEURE**

Accept (Initial)	Reject (Initial)	Reject & Provide Alternative within ITB Response (Initial)	NOTES/COMMENTS:
			

Neither party shall be liable for any costs or damages, or for default resulting from its inability to perform any of its obligations under the contract due to a natural or man-made event outside the control and not the fault of the affected party ("Force Majeure Event"). The Party so affected shall immediately make a written request for relief to the other party and shall have the burden of proof to justify the request. The other Party may granted the relief requested; relief may not be unreasonably withheld. Labor disputes with the impacted party's own employees will not be considered a Force Majeure Event.

**P. CONFIDENTIALITY**

Accept (Initial)	Reject (Initial)	Reject & Provide Alternative within ITB Response (Initial)	NOTES/COMMENTS:
			

All materials and information provided by the Parties or acquired by a Party on behalf of the other Party shall be regarded as confidential information. All materials and information provided or acquired shall be handled in accordance with federal and state law, and ethical standards. Should said confidentiality be breached by a Party, the Party shall notify the other Party immediately of said breach and take immediate corrective action.

It is incumbent upon the Parties to inform their officers and employees of the penalties for improper disclosure imposed by the Privacy Act of 1974, 5 U.S.C. 552a. Specifically, 5 U.S.C. 552a (i)(1), which is made applicable by 5 U.S.C. 552a (m)(1), provides that any officer or employee, who by virtue of his/her employment or official position has possession of or access to agency records which contain individually identifiable information, the disclosure of which is prohibited by the Privacy Act or regulations established thereunder, and who knowing that disclosure of the specific material is prohibited, willfully discloses the material in any manner to any person or agency not entitled to receive it, shall be guilty of a misdemeanor and fined not more than \$5,000.

**III. VENDOR DUTIES**

**A. INDEPENDENT VENDOR / OBLIGATIONS**

Accept (Initial)	Reject (Initial)	Reject & Provide Alternative within ITB Response (Initial)	NOTES/COMMENTS:
			

It is agreed that the Vendor is an independent contractor and that nothing contained herein is intended or should be construed as creating or establishing a relationship of employment, agency, or a partnership.

The Vendor is solely responsible for fulfilling the contract. The Vendor or the Vendor's representative shall be the sole point of contact regarding all contractual matters.

The Vendor shall secure, at its own expense, all personnel required to perform the services under the contract. The personnel the Contractor uses to fulfill the contract shall have no contractual or other legal relationship with the State; they shall not be considered employees of the State and shall not be entitled to any compensation, rights, or benefits from the State, including but not limited to, tenure rights, medical and hospital care, sick and vacation leave, severance pay, or retirement benefits.

By-name personnel commitments made in the Vendor's bid shall not be changed without the prior written approval of the State. Replacement of these personnel, if approved by the State, shall be with personnel of equal or greater ability and qualifications.

The Vendor warrants that all persons assigned to the project shall be employees of the Vendor or a Subcontractor and shall be fully qualified to perform the work required herein. Personnel employed by the Vendor or a subcontractor to fulfill the terms of the contract shall remain under the sole direction and control of the Contractor or the subcontractor respectively.

With respect to its employees, the Vendor agrees to be solely responsible for the following:

1. Any and all pay, benefits, and employment taxes and/or other payroll withholding;
2. Any and all vehicles used by the Vendor's employees, including all insurance required by state law;
3. Damages incurred by Vendor's employees within the scope of their duties under the contract;
4. Maintaining Workers' Compensation and health insurance that complies with state and federal law and submitting any reports on such insurance to the extent required by governing law;
5. Determining the hours to be worked and the duties to be performed by the Vendor's employees; and,
6. All claims on behalf of any person arising out of employment or alleged employment (including without limit claims of discrimination alleged against the Vendor, its officers, agents, or subcontractors or subcontractor's employees).

If the Vendor intends to utilize any subcontractor, the Subcontractor's level of effort, tasks, and time allocation must be clearly defined in the Vendor's bid. The Vendor shall agree that it will not utilize any Subcontractors not specifically included in its proposal in the performance of the contract without the prior written authorization of the State.

The State reserves the right to require the Vendor to reassign or remove from the project any Vendor or Subcontractor employee.

Vendor shall insure that the terms and conditions contained in any contract with a sub-contractor does not conflict with the terms and conditions of this contract.

The Vendor shall include a similar provision, for the protection of the State, in the contract with any Subcontractor engaged to perform work on this contract.

**B. EMPLOYEE WORK ELIGIBILITY STATUS**

The Vendor is required and hereby agrees to use a federal immigration verification system to determine the work eligibility status of employees physically performing work within the State. A federal immigration verification system means the electronic verification of the work authorization program authorized by the Illegal Immigration Reform and Immigrant Responsibility Act of 1996, 8 U.S.C. 1324a, known as the E-Verify Program, or an equivalent federal

program designated by the United States Department of Homeland Security or other federal agency authorized to verify the work eligibility status of an employee.

If the Vendor is an individual or sole proprietorship, the following applies:

1. The Vendor must complete the United States Citizenship Attestation Form, available on the DAS website at <http://das.nebraska.gov/materiel/purchasing.html>

The completed United States Attestation Form should be submitted with the solicitation response.

2. If the Vendor indicates on such attestation form that he or she is a qualified alien, the Vendor agrees to provide the U.S. Citizenship and Immigration Services documentation required to verify the Vendor's lawful presence in the United States using the Systematic Alien Verification for Entitlements (SAVE) Program.
3. The Vendor understands and agrees that lawful presence in the United States is required, and the Vendor may be disqualified, or the contract terminated if such lawful presence cannot be verified as required by Neb. Rev. Stat. § 4-108.

**C. COMPLIANCE WITH CIVIL RIGHTS LAWS AND EQUAL OPPORTUNITY EMPLOYMENT / NONDISCRIMINATION (Statutory)**

The Vendor shall comply with all applicable local, state, and federal statutes and regulations regarding civil rights laws and equal opportunity employment. The Nebraska Fair Employment Practice Act prohibits Vendors of the State, and their Subcontractors, from discriminating against any employee or applicant for employment, with respect to hire, tenure, terms, conditions, compensation, or privileges of employment because of race, color, religion, sex, disability, marital status, or national origin (Neb. Rev. Stat. §§ 48-1101 through 48-1125). The Vendor guarantees compliance with the Nebraska Fair Employment Practice Act, and breach of this provision shall be regarded as a material breach of contract. The Vendor shall insert a similar provision in all Subcontracts for goods or services to be covered by any contract resulting from this solicitation.

**D. COOPERATION WITH OTHER VENDORS**

Accept (Initial)	Reject (Initial)	Reject & Provide Alternative within ITB Response (Initial)	NOTES/COMMENTS:
B			

Vendor may be required to work with or in close proximity to other vendors or individuals that may be working on the same or different projects. The Vendor shall agree to cooperate with such other vendors or individuals and shall not commit or permit any act which may interfere with the performance of work by any other vendor or individual. Vendor is not required to compromise Vendor's intellectual property or proprietary information unless expressly required to do so by this contract.

**E. DISCOUNTS**

Prices quoted shall be inclusive of ALL trade discounts. Cash discount terms of less than thirty (30) days will not be considered as part of the bid. Cash discount periods will be computed from the date of receipt of a properly executed claim voucher or the date of completion of delivery of all items in a satisfactory condition, whichever is later.

**F. PRICES**

Prices quoted shall be net, including transportation and delivery charges fully prepaid by the vendor, F.O.B. destination named in the ITB. No additional charges will be allowed for packing, packages, or partial delivery costs. When an arithmetic error has been made in the extended total, the unit price will govern.

All prices, costs, and terms and conditions submitted in the bid shall remain fixed and valid commencing on the opening date of the bid until an award is made or the ITB is cancelled.

**The State will be given full proportionate benefit of any decreases for the term of the contract.**



**G. COST CLARIFICATION**

The State reserves the right to review all aspects of cost for reasonableness and to request clarification of any bid where the cost component shows significant and unsupported deviation from industry standards or in areas where detailed pricing is required.

**H. PERMITS, REGULATIONS, LAWS**

Accept (Initial)	Reject (Initial)	Reject & Provide Alternative within ITB Response (Initial)	NOTES/COMMENTS:
			

The contract price shall include the cost of all royalties, licenses, permits, and approvals, whether arising from patents, trademarks, copyrights or otherwise, that are in any way involved in the contract. The Vendor shall obtain and pay for all royalties, licenses, and permits, and approvals necessary for the performance of the contract. The Vendor must guarantee that it has the full legal right to the materials, supplies, equipment, software, and other items used to execute this contract.

**I. OWNERSHIP OF INFORMATION AND DATA / DELIVERABLES**

Accept (Initial)	Reject (Initial)	Reject & Provide Alternative within ITB Response (Initial)	NOTES/COMMENTS:
			

The State shall have the unlimited right to publish, duplicate, use, and disclose all information and data developed or obtained by the Vendor on behalf of the State pursuant to this contract.

The State shall own and hold exclusive title to any deliverable developed as a result of this contract. Vendor shall have no ownership interest or title, and shall not patent, license, or copyright, duplicate, transfer, sell, or exchange, the design, specifications, concept, or deliverable.

**J. NOTICE OF POTENTIAL VENDOR BREACH**

Accept (Initial)	Reject (Initial)	Reject & Provide Alternative within ITB Response (Initial)	NOTES/COMMENTS:
			

If Vendor breaches the contract or anticipates breaching the contract the Vendor shall immediately give written notice to the State. The notice shall explain the breach or potential breach, and may include a request for a waiver of the breach if so desired. The State may, at its discretion, temporarily or permanently waive the breach. By granting a temporary waiver, the State does not forfeit any rights or remedies to which the State is entitled by law or equity, or pursuant to the provisions of the contract. Failure to give immediate notice, however, may be grounds for denial of any request for a waiver of a breach.

**K. ANTITRUST**

Accept (Initial)	Reject (Initial)	Reject & Provide Alternative within ITB Response (Initial)	NOTES/COMMENTS:
			

The Vendor hereby assigns to the State any and all claims for overcharges as to goods and/or services provided in connection with this contract resulting from antitrust violations which arise under antitrust laws of the United States and the antitrust laws of the State.

**L. CONFLICT OF INTEREST**

Accept (Initial)	Reject (Initial)	Reject & Provide Alternative within ITB Response (Initial)	NOTES/COMMENTS:
			

By submitting a bid, bidder certifies that no relationship exists between the bidder and any person or entity which either is, or gives the appearance of, a conflict of interest related to this ITB.

Bidder further certifies that bidder will not employ any individual known by bidder to have a conflict of interest nor shall bidder take any action or acquire any interest, either directly or indirectly, which will conflict in any manner or degree with the performance of its contractual obligations hereunder or which creates an actual or appearance of conflict of interest.

If there is an actual or perceived conflict of interest, bidder shall provide with its bid a full disclosure of the facts describing such actual or perceived conflict of interest and a proposed mitigation plan for consideration. The State will then consider such disclosure and proposed mitigation plan and either approve or reject as part of the overall bid evaluation.

**M. STATE PROPERTY**

Accept (Initial)	Reject (Initial)	Reject & Provide Alternative within ITB Response (Initial)	NOTES/COMMENTS:
			

The Vendor shall be responsible for the proper care and custody of any State-owned property which is furnished for the Vendor's use during the performance of the contract. The Vendor shall reimburse the State for any loss or damage of such property; normal wear and tear is expected.

**N. SITE RULES AND REGULATIONS**

Accept (Initial)	Reject (Initial)	Reject & Provide Alternative within ITB Response (Initial)	NOTES/COMMENTS:
			

The Vendor shall use its best efforts to ensure that its employees, agents, and Subcontractors comply with site rules and regulations while on State premises. If the Vendor must perform on-site work outside of the daily operational hours set forth by the State, it must make arrangements with the State to ensure access to the facility and the equipment has been arranged. No additional payment will be made by the State on the basis of lack of access, unless the State fails to provide access as agreed to in writing between the State and the Vendor.

**O. ADVERTISING**

Accept (Initial)	Reject (Initial)	Reject & Provide Alternative within ITB Response (Initial)	NOTES/COMMENTS:
			

The Vendor agrees not to refer to the contract award in advertising in such a manner as to state or imply that the company or its goods and services are endorsed or preferred by the State. Any publicity releases pertaining to the project shall not be issued without prior written approval from the State.

**P. DISASTER RECOVERY/BACK UP PLAN**

Accept (Initial)	Reject (Initial)	Reject & Provide Alternative within ITB Response (Initial)	NOTES/COMMENTS:
			

The Vendor shall have a disaster recovery and back-up plan, of which a copy should be provided upon request to the State, which includes, but is not limited to equipment, personnel, facilities, and transportation, in order to continue delivery of goods and services as specified under the specifications in the contract in the event of a disaster.

**Q. DRUG POLICY**

Accept (Initial)	Reject (Initial)	Reject & Provide Alternative within ITB Response (Initial)	NOTES/COMMENTS:
			

Vendor certifies it maintains a drug free workplace environment to ensure worker safety and workplace integrity. Vendor agrees to provide a copy of its drug free workplace policy at any time upon request by the State.

**R. WARRANTY**

Accept (Initial)	Reject (Initial)	Reject & Provide Alternative within ITB Response (Initial)	NOTES/COMMENTS:

A			
---	--	--	--

Despite any clause to the contrary, the Vendor represents and warrants that its services hereunder shall be performed by competent personnel and shall be of professional quality consistent with generally accepted industry standards for the performance of such services and shall comply in all respects with the requirements of this Contract. For any breach of this warranty, the Vendor shall, for a period of ninety (90) days from performance of the service, perform the services again, at no cost to Customer, or if Vendor is unable to perform the services as warranted, Vendor shall reimburse Customer the fees paid to Vendor for the unsatisfactory services. The rights and remedies of the parties under this warranty are in addition to any other rights and remedies of the parties provided by law or equity, including, without limitation actual damages, and, as applicable and awarded under the law, to a prevailing party, reasonable attorneys' fees, and costs.

**IV. PAYMENT**

**A. PROHIBITION AGAINST ADVANCE PAYMENT (Statutory)**

Neb. Rev. Stat. §§81-2403 states, “[n]o goods or services shall be deemed to be received by an agency until all such goods or services are completely delivered and finally accepted by the agency.”

**B. TAXES (Statutory)**

The State is not required to pay taxes and assumes no such liability as a result of this solicitation. The Vendor may request a copy of the Nebraska Department of Revenue, Nebraska Resale or Exempt Sale Certificate for Sales Tax Exemption, Form 13 for their records. Any property tax payable on the Vendor’s equipment which may be installed in a state-owned facility is the responsibility of the Vendor.

**C. INVOICES**

Invoices for payments must be submitted by the Vendor to the agency requesting the services with sufficient detail to support payment. The terms and conditions included in the Vendor’s invoice shall be deemed to be solely for the convenience of the parties. No terms or conditions of any such invoice shall be binding upon the State, and no action by the State, including without limitation the payment of any such invoice in whole or in part, shall be construed as binding or estopping the State with respect to any such term or condition, unless the invoice term or condition has been previously agreed to by the State as an amendment to the contract.

Invoices will be submitted to [dcs.accounts payable@nebraska.gov](mailto:dcs.accounts payable@nebraska.gov)

**D. INSPECTION AND APPROVAL**

Accept (Initial)	Reject (Initial)	Reject & Provide Alternative within ITB Response (Initial)	NOTES/COMMENTS:
			

Final inspection and approval of all work required under the contract shall be performed by the designated State officials.

**E. PAYMENT (Statutory)**

Payment will be made by the responsible agency in compliance with the State of Nebraska Prompt Payment Act (See Neb. Rev. Stat. §81-2403). The State may require the Vendor to accept payment by electronic means such as ACH deposit. In no event shall the State be responsible or liable to pay for any goods and services provided by the Vendor prior to the Effective Date of the contract, and the Vendor hereby waives any claim or cause of action for any such services.

**F. LATE PAYMENT (Statutory)**

The Vendor may charge the responsible agency interest for late payment in compliance with the State of Nebraska Prompt Payment Act (See Neb. Rev. Stat. §§ 81-2401 through 81-2408).

**G. SUBJECT TO FUNDING / FUNDING OUT CLAUSE FOR LOSS OF APPROPRIATIONS (Statutory)**

The State’s obligation to pay amounts due on the Contract for a fiscal year following the current fiscal year is contingent upon legislative appropriation of funds. Should said funds not be appropriated, the State may terminate the contract with respect to those payments for the fiscal year(s) for which such funds are not appropriated. The State will give the Vendor written notice thirty (30) calendar days prior to the effective date of termination. All obligations of the State to make payments after the termination date will cease. The Vendor shall be entitled to receive just and equitable compensation for any authorized work which has been satisfactorily completed as of the termination date. In no event shall the Vendor be paid for a loss of anticipated profit.

**H. RIGHT TO AUDIT (First Paragraph is Statutory)**

The State shall have the right to audit the Vendor’s performance of this contract upon a thirty (30) day written notice. Vendor shall utilize generally accepted accounting principles, and shall maintain the accounting records, and other records and information relevant to the contract (Information) to enable the State to audit the contract. (Neb. Rev. Stat. § 84-304 et seq.) The State may audit, and the Vendor shall maintain the information during the term of the contract and for a period of five (5) years after the completion of this contract or until all issues or litigation are resolved, whichever is later. The Vendor shall make the Information available to the State at Vendor’s place of

business or a location acceptable to both Parties during normal business hours. If this is not practical or the Vendor so elects, the Vendor may provide electronic or paper copies of the Information. The State reserves the right to examine, make copies of, and take notes on any Information relevant to this contract, regardless of the form or the Information, how it is stored, or who possesses the Information. In no circumstances will vendor be required to create or maintain documents not kept in the ordinary course of vendor's business operations, nor will contractor be required to disclose any information, including but not limited to product cost data, which is confidential or proprietary to vendor.

Accept (Initial)	Reject (Initial)	Reject & Provide Alternative within ITB Response (Initial)	NOTES/COMMENTS:
A			

The Parties shall pay their own costs of the audit unless the audit finds a previously undisclosed overpayment by the State. If a previously undisclosed overpayment exceeds one-half of one percent to three percent (.5% to 3%) of the total contract billings, or if fraud, material misrepresentations, or non-performance is discovered on the part of the Vendor, the Vendor shall reimburse the State for the total costs of the audit. Overpayments and audit costs owed to the State shall be paid within ninety (90) days of written notice of the claim. The Vendor agrees to correct any material weaknesses or condition found as a result of the audit.

**V. SCOPE OF WORK**

The Bidder must provide the following information in response to this ITB.

**A. SCOPE**

It is the intent of this bid invitation to issue a purchase order for Southern Folger Locks for Tecumseh State Correctional Institution.

All items proposed shall be of the latest manufacture in production as of the date of the solicitation and be of proven performance and under standard design complete as regularly advertised and marketed. All necessary materials for satisfactory performance of the supplies shall be incorporated into the Southern Folger Locks for Tecumseh State Correctional Institution whether or not they may be specifically mentioned below.

Complete specifications, manufacturer's current descriptive literature and/or advertising data sheets with cuts or photographs must be included with the bid for the IDENTICAL items proposed. Any information necessary to show compliance with these specifications not given on the manufacturer's descriptive literature and/or advertising data sheets must be supplied in writing on or attached to the bid document. If manufacturer's information necessary to show compliance with these specifications is not attached to the bid document, the Bidder may be required to submit requested information within three (3) business days of a written request. Failure to submit requested descriptive literature or advertising data sheets may be grounds to reject the bid.

**VI. TECHNICAL SPECIFICATIONS**

**A. BIDDER INSTRUCTIONS**

Bidder must respond to each of the following statements. Specifications listed are minimum conditions that must be met in order for a Bidder to qualify for the award.

"YES" response means the Bidder guarantees they can meet this condition.

"NO" response means the Bidder cannot meet this condition and will not be considered.

"NO & PROVIDE ALTERNATIVE" responses should be used only with a narrative response in the NOTES/COMMENTS section explaining in detail any deviation from the Bidder's ability to meet the condition, and an explanation of how this would be determined to be an acceptable alternative to meeting the condition. Alternatives must be detailed in such a way that allows such deviations to be fully evaluated. The State shall determine at its sole discretion whether or not the Bidder's alternative is an acceptable alternative.

**B. NON-COMPLIANCE STATEMENT**

YES	NO	NO & PROVIDE ALTERNATIVE	
✓			<p>1. Read these specifications carefully. Any and all exceptions to these specifications must be written on or attached to solicitation response. Any noncompliance may void your bid. Non-compliance to any single specification can void your bid.</p>
✓			<p>2. It is the responsibility of Bidders to obtain information and clarifications as provided below. The State is not responsible for any erroneous or incomplete understandings or wrongful interpretations of this solicitation by any Bidder.</p>
✓			<p>3. No interpretation related to the meaning of solicitation specifications or other pre-bid documents will be made orally to any Bidder by the State. Any solicitation interpretation must be put in writing by the Bidder to the State Purchasing Bureau,</p> <p>Submit questions to SPB via the share file Link:  <a href="https://nebraska.sharefile.com/r-r4c21937b591745d08449dbe9bdb82429">https://nebraska.sharefile.com/r-r4c21937b591745d08449dbe9bdb82429</a>                      by the last day to submit written questions per the Schedule of Events. (Inquiries received after the last day to submit written questions may not be addressed).</p>

NOTES/COMMENTS:

**C. TECHNICAL SPECIFICATIONS: SOUTHERN FOLGER LOCKS**

YES	NO	NO & PROVIDE ALTERNATIVE	
✓			1. Manufacturer: Southern Folger Brand Name: Southern Steel Model: 1010.01AM-1-RH-FP
✓			2. Deadlock with one (1) side, M-Keyway, 1/2' Projection to Code
✓			3. No alternatives will be accepted.
✓			4. Upon award to authorized distributor or manufacturer, NE Department of Correctional Services will provide keying information.
✓			5. Awarded Vendor may be required to certify that they are in good standing with the manufacturer and comply with all confidentiality agreements from the manufacturer and NDCS.

NOTES/COMMENTS:

**D. ACCEPTABLE BRANDS**

YES	NO	NO & PROVIDE ALTERNATIVE	
✓			1. Products proposed must be the brand AND model numbers as specified on each line of the Solicitation Document. The State will not be accepting alternatives to the brands specified: Southern Folger 1010.01AM-1-RH-FP
✓			2. Equipment proposed shall be the latest current models in production as of the date of the solicitation and be of proven performance and under standard design, complete as regularly advertised and marketed and shall be delivered complete with all necessary parts, specified accessories, tools, and special features, whether or not they may be specifically mentioned below.
✓			3. Used, demonstrator, prototype, or discontinued equipment is not acceptable. Complete specifications, manufacturer's descriptive literature and/or advertising data sheets with cuts or photographs may be required prior to an award and should be included with the bid on the IDENTICAL equipment proposed.
✓			4. Literature should be complete and the latest published. Any information necessary to show compliance with these specifications not given on the manufacturer's descriptive literature and/or advertising data sheets should be supplied in writing on or attached to the bid document. All bids must meet or exceed the following requirements.

NOTES/COMMENTS:



**E. DELIVERY ARO**

YES	NO	NO & PROVIDE ALTERNATIVE	
✓			<p>1. Delivery desired within 10-12 weeks after receipt of order(s). NDCS requires tracking information for order shipments to be sent to <a href="mailto:dcg.purchasing@nebraska.gov">dcg.purchasing@nebraska.gov</a>. Deliveries quoted after 12 weeks may be a factor in award consideration.</p> <p><b>Delivery will be <u>8-10</u> weeks after receipt of order.</b></p> <p>At the time of delivery, a designated State employee will sign the "invoice/packing slip." This signature will only indicate that the order has been received and that the items actually delivered agree with the delivery invoice. This signature does not indicate all items were received in good condition and/or that there is not possible hidden damage.</p>
NOTES/COMMENTS:			

**F. DELIVERY LOCATIONS / INSTRUCTIONS (VENDOR AGREES THAT THEY CAN MEET THE DELIVERY LOCATIONS/INSTRUCTIONS)**

YES	NO	NO & PROVIDE ALTERNATIVE	
✓			<p>1. Tecumseh State Correctional Institution                  2. Attn: Steve Klein                  3. 2725 N Hwy 50                  4. Tecumseh, NE 68450</p>
NOTES/COMMENTS:			

**G. PACKAGING**

YES	NO	NO & PROVIDE ALTERNATIVE	
✓			<p>5. Packaging must be of suitable size and of sufficient strength to protect the contents during shipping, handling, and storage.</p>
NOTES/COMMENTS:			

**H. ORDERS**

YES	NO	NO & PROVIDE ALTERNATIVE	
✓			<p>1. Orders will be placed either by, phone, e-mail, or Internet (if available and not to the exclusion of the other methods).</p>
✓			<p>2. All orders must reference a purchase order number and the purchase order number must be referenced on the packing slip, and invoice. Invoices are to be sent to the "Invoice to" address on the purchase order.</p>

**NOTES/COMMENTS:**

**I. QUALITY**

YES	NO	NO & PROVIDE ALTERNATIVE	
✓			1. Product quality must meet specifications and be consistent for the term of the contract. All materials must be of first quality, under standard production by the manufacturer and be of standard design, complete as regularly advertised and marketed and be of proven performance.
✓			2. A guarantee of satisfactory performance by the contractor and meeting delivery dates are considered to be an integral part of the purchase contract resulting from this proposal invitation.
✓			3. Products are to be fully guaranteed and may be returned for full credit or replacement (at the State's option) for any reason during the initial warranty period with no additional charges for shipping or restocking.

**NOTES/COMMENTS:**

**J. GRAY MARKET PRODUCTS PROHIBITION**

YES	NO	NO & PROVIDE ALTERNATIVE	
✓			1. The State will not accept Gray Market Products for this solicitation. Gray Market is defined as the trade of a commodity through distribution channels which, while legal, are unofficial, unauthorized, or unintended by the original manufacturer. Gray Market items are not designed to be sold in a particular market and cannot be supported by the authorized importer because of various reasons.

**NOTES/COMMENTS:**

**K. AUTHORIZED DEALER & WARRANTY**

YES	NO	NO & PROVIDE ALTERNATIVE	
✓			1. To the extent required by the manufacturer, the Contractor shall be an authorized dealer. Vendor may be required to substantiate that he/she is an authorized dealer. Proof, if required, must be submitted to SPB within three (3) business days of the request and prior to the award of any contract.
✓			2. The terms of the original manufacturer's standard warranty shall apply to all equipment acquired from this solicitation for the entire warranty period.
✓			3. NE Department of Correctional Services will only issue keying code authorization to manufacturer or manufacturer's authorized distributors, due to the security nature of this product.

NOTES/COMMENTS:

**L. WARRANTY**

YES	NO	NO & PROVIDE ALTERNATIVE	
✓			<p>1. The Vendor warrants for a period of one (1) year from the date of Acceptance that: (a) the Products perform according to all specific claims that the Vendor made in its response to the solicitation, (b) the Product is suitable for the ordinary purposes for which such Product is used, (c) the Product is suitable for any special purposes identified in the solicitation or for which the State has relied on the Vendor's skill or judgment, (d) the Product is designed and manufactured in a commercially reasonable manner, and (e) the Product is free of defects. Upon breach of the warranty, the Vendor will repair or replace (at no charge to the State) the Product whose nonconformance is discovered and made known to the Vendor. If the repaired and/or replaced Product proves to be inadequate, or fails of its essential purpose, the Vendor will refund the full amount of any payments that have been made. The rights and remedies of the parties under this warranty are in addition to any other rights and remedies of the parties provided by law or equity, including, without limitation actual damages, and, as applicable and awarded under the law, to a prevailing party, reasonable attorneys' fees, and costs.</p>

NOTES/COMMENTS:

**M. SAMPLES**

YES	NO	NO & PROVIDE ALTERNATIVE	
✓			<p>1. Samples of materials proposed may be required prior to an award, or at any time during the term of the contract.</p>
	✓	SAMPLES ARE SUBJECT TO LEAD TIMES UP TO 8-10 WEEKS	<p>2. Samples are to be provided within twenty-one (21) business days of a written request.</p>
✓			<p>3. Failure to provide samples or samples not meeting the specifications may void the bid or constitute a breach of the contract resulting from this bid invitation.</p>
✓			<p>4. Samples to be shipped to the following address:            Tecumseh State Correctional Institution:            Attn Steve Klein            2725 N Hwy 50            Tecumseh, NE 68450</p>

NOTES/COMMENTS:

**N. PERFORMANCE TESTING**

YES	NO	NO & PROVIDE ALTERNATIVE	
✓			1. Samples of Southern Folger 1010.01AM-1-RH-FP, in accordance with the specifications utilizing materials and features as proposed, may be required prior to award. One (1) sample only may be requested.
	✓	IF SAMPLE IS KEPT, THE COST WILL BE DEDUCTED FROM AWARDED BID AMOUNT	2. Samples of Southern Folger 1010.01AM-1-RH-FP shall be provided at no cost to the State and will not be returned to the Vendor upon completion of testing conducted by the NDCS
	✓	SAMPLES ARE SUBJECT TO LEAD TIMES UP TO 8-10WEEKS	3. Vendor shall have ten (21) business days to provide sample(s) upon the State's written request.
✓			4. Sample is to be of material and construction as bid. Failure to supply samples and/or sample(s) that do not meet specifications and/or fail any of the protocols/tests as outlined below, may be grounds to reject the bid.
✓			5. Upon a written request from the State of Nebraska Purchasing Bureau, sample(s) shall be shipped to:  Attn: Tecumseh State Correctional Institution 2725 N Hwy 50 Tecumseh, NE 68450 Atten: Steve Klein  Receiving hours are between 8:00 A.M. and 3:00 P.M., Monday through Friday (excluding State holidays and / or as otherwise directed).
✓			6. Sample lock will be tested within a cell door to ensure proper fit.
<p><b>NOTES/COMMENTS:</b> ALTERNATES ARE NEGOTIABLE UPON WRITTEN REQUEST.</p>			

## DOOR MOUNTED FOR SMALL SWINGING DOORS

Medium and maximum security.

# 1010AM DEADLOCK

1010AM-1: KEYED ONE SIDE  
1010AM-2: KEYED BOTH SIDE

### APPLICATION:

For small swinging doors on access panels, plumbing chases, control cabinets, etc.

### FUNCTION:

Mogul key activated locking and unlocking.



## DOOR MOUNTED FOR SMALL SWINGING DOORS

Medium and maximum security.

### STANDARD FEATURES:

- Mechanical deadlock
- 6 pin tumblers
- Mounting fasteners

### OPTIONAL FEATURES:

**EXTENDED BOLT** - Used for stop side mounting. Specify "1-1/4".

**HOLLOW METAL MOUNTING** - Used for hollow metal door application. Specify "HM." (See page G17)

MASTER KEYING AVAILABLE.

**BOLT KEEPER OPTIONS** -  
(Must be specified separately):  
4C - Bolt keeper with dustbox  
4CL - Bolt keeper with switch

**NOTE:** All bolt keepers are supplied with security fasteners.

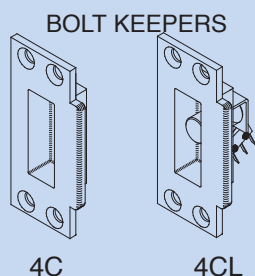

#### HOW TO ORDER:

Specify:

1. Quantity
2. Swing chart number (handing)
3. Bolt projection
4. Application (HM or surface)
5. Key code instruction
6. Bolt keeper requirements

## 1010AM DEADLOCK

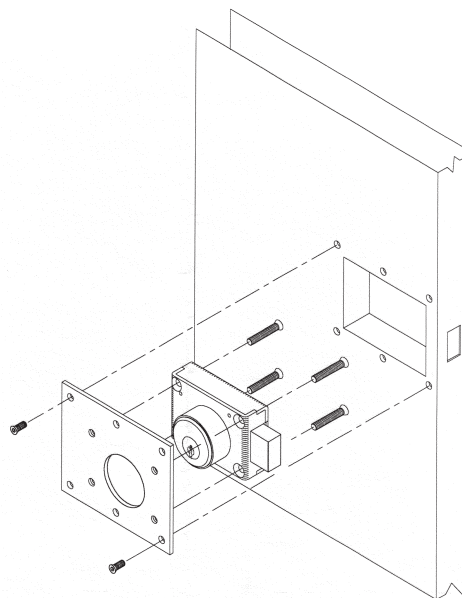

HM Mounting Shown

**Swing Chart:** Specify circled swing number when ordering.

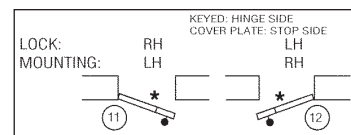
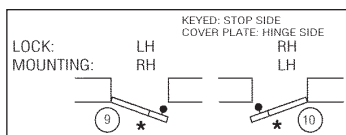
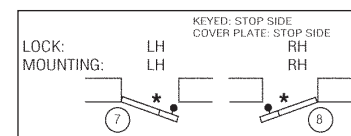
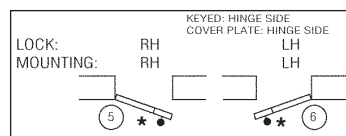

\* Indicates lock mounting/access plate side.

### TECHNICAL DATA:

- **STANDARD FINISH:**  
Galvanized
- **COVER:** Steel
- **CASE:** Steel
- **LOCKBOLT:** Stainless Steel
- **MOGUL CYLINDER:**  
US26D
- **MOGUL KEYS:**  
Nickel Silver
- **PIN TUMBLERS AND ENGAGING BALLS:**  
Combination nickel silver and stainless steel, 6 tumblers per lock.
- **LOCK CASE SIZE:**  
4.4" L x 3.15" H x 1.35" TK
- **LOCK WEIGHT:** 5.5 lbs.
- **LOCKBOLT SIZE:**  
1-1/2" H x 3/4" TK
- **LOCKBOLT THROW:** 5/8"

